



MICRO SWITCH™  
Compact Precision Limit Switches  
**14CE Series**



# MICRO SWITCH™ 14CE Series

## Compact Precision Limit Switches

All MICRO SWITCH™ 14CE Series compact enclosed switches incorporate fluorocarbon diaphragm sealing to provide reliable protection, meeting IP65, IP66, IP67, and IP68 as well as NEMA 1, 2, 3, 3R, 4, 6, 6P, and 13 requirements. Versions with a boot seal also meet NEMA 12 requirements (dust, falling dirt, liquid media with solid contaminants). The cable or connector and basic switch terminals are encapsulated in an epoxy sealant, offering excellent resistance in harsh environments. For low temperature applications (down to -40 °C, -40 °F), CE Series switches can be supplied with low temperature seals and lubricant.

The CE Series switches are rugged and versatile switches which can be applied indoors in many harsh factory floor applications, as well as on outdoor equipment in extreme temperatures. A full range of actuators are available, including plain plungers, roller plungers, side rotary, multi-directional wire, and manually operated. The switches are also available with the industry standard, M12 micro-change 4-pin connector. MICRO SWITCH™ 14CE products meet worldwide CE requirements.

### *What makes our switches better?*

- Compact construction for minimal real estate on equipment
- Gang mounting capability to provide a multi-plunger limit switch
- Rugged, die-cast zinc housing for demanding environments
- Variety of cable length options and choice of side or bottom exit cable/connector for design flexibility
- Functionality over a wide temperature range with factory sealed connectors or wiring



***Big performance in a little package.***

CUSTOMIZATION • COMPACT  
HIGH PERFORMING • DURABILITY

# Features and Benefits

## RUGGED, COMPACT CONSTRUCTION

MICRO SWITCH™ 14CE Series limit switches' compact construction requires **minimal real estate on equipment**. Consistent performance is delivered in many demanding environments where petroleum, synthetic or water based fluids are present. Its die-cast zinc housing and fluorocarbon diaphragm seal maintain a tightly sealed, IP65/66/67/68 and NEMA 1, 2, 3, 3R, 4, 6, 6P, 12 (boot seal), 13 rugged package.

### *Gang-mounting option*

## CUSTOMIZATION

Switches are **pre-leaded** (harmonized CENELEC cable) or supplied with a **M12 four-pin connector** to decrease installation time. 14CE Series' wide selection of actuators **minimize installation or time issues**. Cable length variations are available for equipment requiring different cable lengths with side and bottom exit cable/connector options for equipment flexibility.

## COMPACT DESIGN

Rugged, compact switch designed with the common **25 mm mounting centers**. The 14CE Series is engineered with MICRO SWITCH™ SM switches for **consistent, precise actuation**.

### *High performance switch for small spaces*

## LONG LIFE

Mechanical life up to five million cycles for wobble actuators, and up to ten million cycles for all other actuators delivers **long-lasting performance**.

## DESIGN FLEXIBILITY

Gang mounting capability provides a **multi-plunger limit switch option**. **Low temperature variants** are available for indoor and outdoor applications.

## GLOBAL APPLICATIONS

MICRO SWITCH™ 14CE limit switches have **CE** approval for world-wide use.

## Potential Applications



### **MACHINE TOOLS**

Detects tool and piece part location on CNC and other machining equipment

### **OFF-ROAD EQUIPMENT**

Used as a cab door switch on crane booms

### **MATERIAL HANDLING**

Used in forklifts and dock locks for trucks and trailers, and vehicle wash systems



### **ACCESS AND MOBILITY SOLUTIONS**

Often used on vehicle wheelchair lifts and stairway lifts

### **TEXTILE MACHINERY**

Senses roll size, tensioning, and other functions

### **ROBOTICS**

Controls arm movement limits



### **PACKAGING EQUIPMENT**

Often used on stretch pallet wrapping equipment

### **PRINT TRADE MACHINERY**

Senses roll size, tensioning, along with controlling gates and panels

### **AGRICULTURAL MACHINERY**

Used on grain and livestock equipment

# MICRO SWITCH™ Compact Precision Limit Switches

**Table 1. Specifications**

Characteristic	Parameter
Description	compact enclosed limit switch
Actuators	<ul style="list-style-type: none"> <li>• Top pin plunger (14CE1-)</li> <li>• Cross roller plunger (14CE3-)</li> <li>• Top pin plunger with boot seal (14CE18-)</li> <li>• Wobble (14CE20-)</li> <li>• Top pin plunger, panel mount (14CE27-)</li> <li>• Top roller plunger, parallel and panel mount (14CE28-)</li> <li>• Top roller plunger, perpendicular, panel mount (14CE29-)</li> <li>• Top roller plunger, parallel and boot sealed (14CE31-)</li> <li>• Top roller plunger, perpendicular, boot seal (14CE55-)</li> <li>• Parallel roller plunger (14CE2-)</li> <li>• Front rotary (14CE16-)</li> <li>• Top adjustable plunger (14CE19-)</li> <li>• Manually operated (14CE22-)</li> <li>• Ball bearing plunger (14CE66-)</li> </ul>
Terminations	<p>Harmonized CENELEC PVC sheathed 4 x 0,75 mm<sup>2</sup> (18 AWG) cable</p> <p>Connector (dc), 4-pin male, M12 thread (-Q)</p> <p>Connector (ac), 4-pin male, 1/2 in x 20 thread (-Q1)</p>
Switching options	SPDT, snap action contacts (1NC/1NO)
Sealing	<p>IP65, IP66, IP67, IP68</p> <p>NEMA 1, 2, 3, 3R, 4, 6, 6P, 12 (boot seal), 13</p>
Operating temperature	0 °C to 70 °C [32 °F to 158 °F]; optional -40 °C to 70 °C [-40 °F to 158 °F]
Mechanical life	<p>up to 10 million</p> <p>up to 5 million (wobble actuators)</p>
Thermal current	1 A, 3 A, 5 A (depending upon model)
Rated insulation voltage (Ui)	250 V
Rated impulse withstand voltage (Uimp)	1.5 kV
Pollution degree	3
Min. actuation speed	0.003 m/s
Max. actuation speed	0.1 m/s
Max. actuation frequency	ac – 200 Hz; dc – 20 Hz
Shock	50 g – IEC68-2-27
Vibration	10 G – IEC68-2-6
Approvals	CE
Conforming to standards	IEC947-5-1, EN 60947-5-1; AC14 D300, DC13 R300

**Table 2. Electrical Ratings (in amperes)**

Model example	Contacts	Rating
14CE_ _	Silver contacts	A
14CE_ _G	Gold contacts	B
14CE_ -Q, -AQ, -AQ1	Silver contacts	C with 4-pin connector

Rating code	Electrical Rating	Make	Break
A	240 Vac, ind.	1.2	0.2
	240 Vac, res.	5	5
	28 Vdc, res.	3	3
	28 Vdc, ind.	3	3
	5 A, 1/10 HP, 125 Vac or 250 Vac	–	–
B	1 A res., 0.5 A ind., 30 Vdc	–	–
	1 A, 125 Vac	–	–
C	3 A, 125 Vac or 250 Vac	–	–

# 14CE Series

## SWITCHING AND LEAD IDENTIFICATION

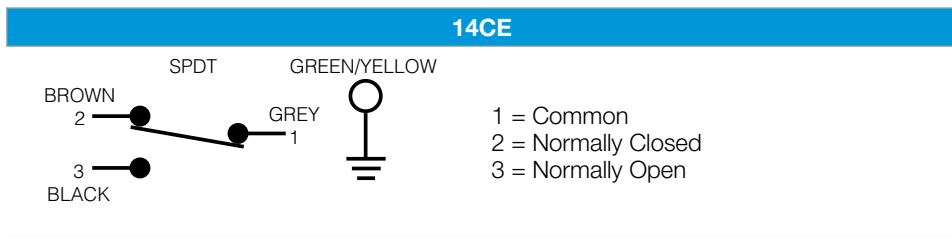

## PINOUTS



## CONNECTOR VERSIONS

The 14CE Series is available with a 4-pin, M12 size connector in both bottom and side exit versions.

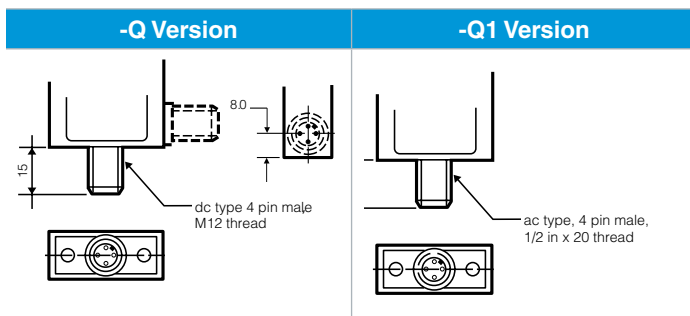

## MOUNTING

MICRO SWITCH™ 14CE Series switches are mounted by using two M5 screws. The mounting holes are counter bored to keep the screw heads within the overall switch housing dimensions.

## GANG MOUNT CAPABILITY

The housing on the 14CE Series has been designed to enable the user to build his own multiple plunger switch by gang mounting several switches. All pin plunger and roller plunger types are suitable for gang mounting. There is a 16 mm distance between the plungers. Both Series are very versatile that even a lever-type version could be added at the end of the row.

## BOTTOM EXIT OR SIDE EXIT ORIENTATION

The CE Series has been designed with a pre-wired cable or connector fitted in the bottom of the switch housing. Other variations are available with a side-exit cable or connector.

## GOLD CONTACT VERSIONS

For low energy applications (up to 30 Vdc, 1 A), gold contact versions of the 14CE switches can be supplied upon request.



# MICRO SWITCH™ Compact Precision Limit Switches

## GENERAL DIMENSIONS • ALL SWITCHES

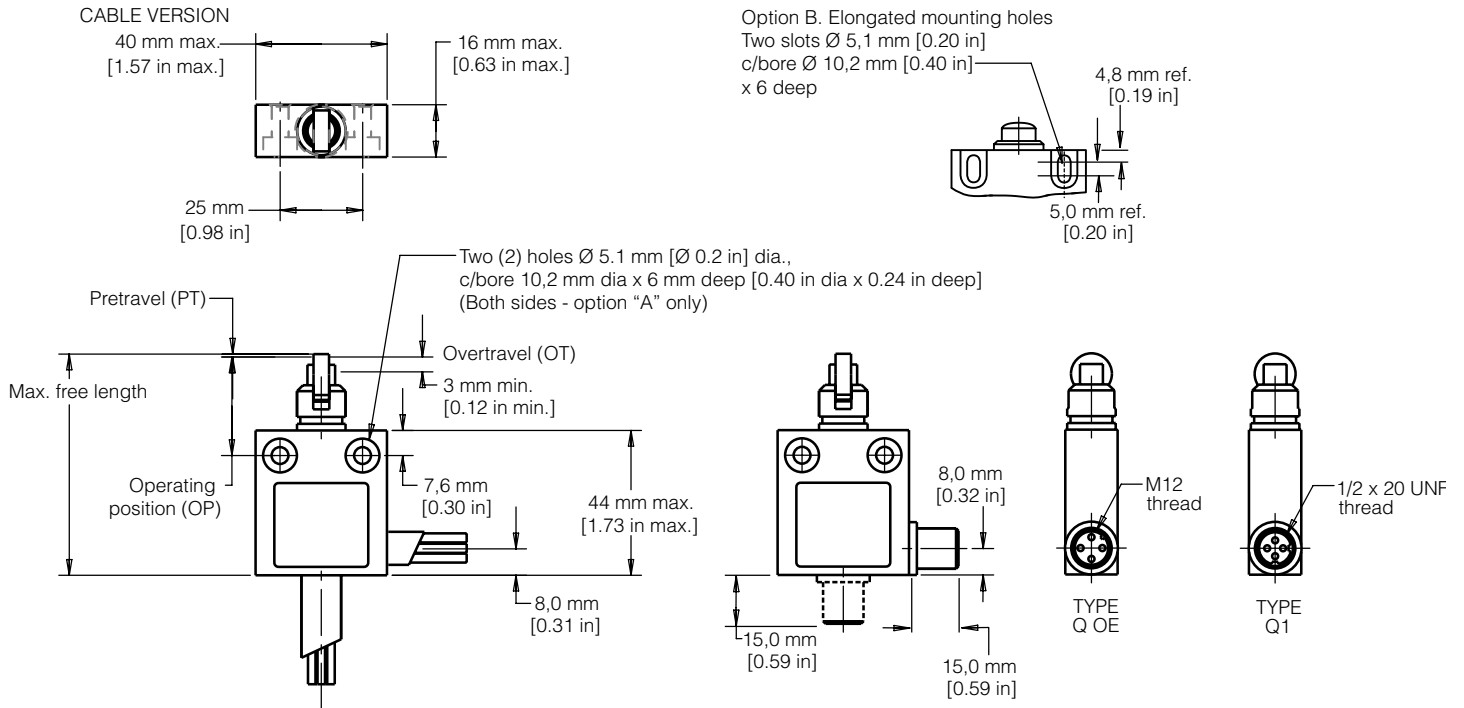

## PRODUCT NOMENCLATURE

14CE	16	—	3		
Switch Type	Actuator Type		Cable Length	Options <sup>1,2</sup>	Connectors (micro type)
<b>14CE Series Compact Precision Limit Switch</b>	<b>1</b> Top pin plunger	<b>22</b> Manually oper. nylon button	<b>1</b> 1 meter	<b>A</b> Side entry	<b>Q</b> dc type single keyway 4-pin male, M12
	<b>2</b> Top roller plunger, parallel	<b>27</b> Top pin plunger panel mount	<b>2</b> 2 meters	<b>B</b> Elongated mounting holes	<b>Q1</b> ac type two keyways 4-pin male, 1/2-20
	<b>3</b> Top roller plunger, perp.	<b>28</b> Top roller plunger, parallel panel mount	<b>3</b> 3 meters	<b>D</b> Halogen-free cable	
	<b>16</b> Front rotary	<b>29</b> Top roller plunger, perp. panel mount	<b>4</b> 4 meters	<b>G</b> Gold contacts	
	<b>18</b> Top pin plunger w/ boot seal	<b>31</b> Top roller plunger, parallel boot seal	<b>5</b> 5 meters	<b>H</b> High temp., 150 °C	
	<b>19</b> Top adjustable pin plunger	<b>55</b> Top roller plunger, perp. boot seal		<b>L</b> Low temp., -40 °C switch and cable	
	<b>20</b> Coil wobble	<b>66</b> Top ball bearing plunger		<b>L1</b> Low temp., -40 °C, cable not for flexing	
				<b>P</b> Top mounting	
				<b>V</b> Fluorocarbon seals/gasket (front rotary only)	

NOTE: not all combinations of model code are available. Please contact your Honeywell provider/representative for assistance.

<sup>1</sup>More than one option may be permissible.

<sup>2</sup>OPTION K to be discontinued. Replaced with fluorocarbon diaphragm seal, standard switch.

<sup>2</sup>OPTION KV to be discontinued. Replaced with fluorocarbon diaphragm seal, standard switch.

Bottom exit is standard.

# 14CE Series

## PRODUCT SPECIFICATIONS AND LISTINGS

Contact your Honeywell rep or distributor for additional listings

14CE1 • Pin Plunger 14CE27 • Pin Plunger Panel Mount		Con- tacts	Elec Rating <sup>1</sup>	Cable Exit	Free Position (FP)	Operating Position (OP)	Options	Listing
<p> <b>Pretravel</b> • 1,8 mm [0.071 in]  <b>Diff. travel</b> • 0,1 mm [0.004 in]  <b>Overtravel</b> • 3,0 mm [0.118 in]  <b>Oper. force</b> • 11,8 N [2.65 lb]                 </p>		Silver	A	Bottom	17,5 mm [0.69 in]	15,7 mm [0.62 in]	–	<b>14CE1-1</b>
		Gold	B	Bottom	17,5 mm [0.69 in]	15,7 mm [0.62 in]	Gold-plated contacts	<b>14CE1-1G</b>
		Silver	A	Side	17,5 mm [0.69 in]	15,7 mm [0.62 in]	Side exit cable	<b>14CE1-1A</b>
		Silver	C	Bottom	17,5 mm [0.69 in]	15,7 mm [0.62 in]	dc-type connector	<b>14CE1-Q</b>
		Silver	A	Bottom	31,1 mm [1.23 in]	29,3 mm [1.15 in]	Panel mount	<b>14CE27-1</b>
14CE18 • Boot Sealed Pin Plunger		Con- tacts	Elec Rating <sup>1</sup>	Cable Exit	Free Position (FP)	Operating Position (OP)	Options	Listing
<p> <b>Pretravel</b> • 1,8 mm [0.071 in]  <b>Diff. travel</b> • 0,1 mm [0.004 in]  <b>Overtravel</b> • 3,0 mm [0.118 in]  <b>Oper. force</b> • 22,5 N [5.06 lb]                 </p>		Silver	A	Bottom	26,7 mm [1.05]	24,9 mm [0.98 in]	–	<b>14CE18-1</b>
		Silver	A	Side	26,7 mm [1.05]	24,9 mm [0.98 in]	Side exit cable	<b>14CE18-1A</b>
		Silver	C	Bottom	26,7 mm [1.05]	24,9 mm [0.98 in]	dc-type connector	<b>14CE18-Q</b>
14CE66 • Ball Bearing Plunger		Con- tacts	Elec Rating <sup>1</sup>	Cable Exit	Free Position (FP)	Operating Position (OP)	Options	Listing
<p> <b>Pretravel</b> • 1,8 mm [0.071 in]  <b>Diff. travel</b> • 0,1 mm [0.004 in]  <b>Overtravel</b> • 3,0 mm [0.118 in]  <b>Oper. force</b> • 11,8 N [2.65 lb]                 </p>		Silver	A	Bottom	26,2 mm [1.03 in]	24,4 mm [0.96 in]	–	<b>14CE66-1</b>
		Silver	A	Side	26,2 mm [1.03 in]	24,4 mm [0.96 in]	Side exit cable	<b>14CE66-1A</b>

<sup>1</sup> Page 5 for electrical codes

Note: Most part numbers are shown with 1 meter of cable. The -X indicates the number of meters of cable provided: 2-meters, 3-meters, 4-meters, and 5-meters. Custom lengths are also available.



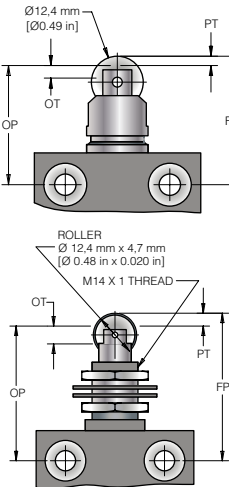
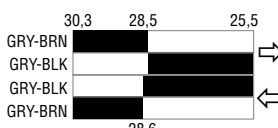
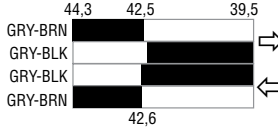
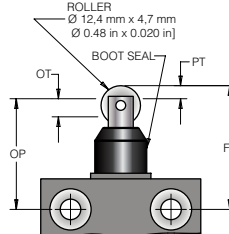
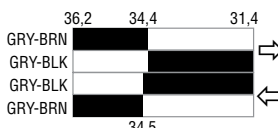
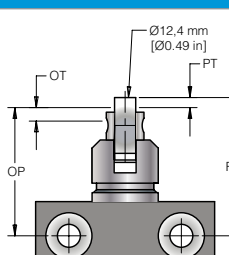
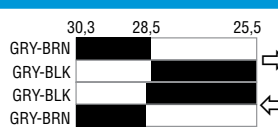

# MICRO SWITCH™ Compact Precision Limit Switches

14CE2 • Roller Plunger 14CE28 • Roller Plunger Panel Mount		Con- tacts	Elec Rating <sup>1</sup>	Cable Exit	Free Position (FP)	Operating Position (OP)	Options	Listing
 <p> <b>Pretravel</b> • 1,8 mm [0.071 in]  <b>Diff. travel</b> • 0,1 mm [0.004 in]  <b>Overtravel</b> • 3,0 mm [0.118 in]  <b>Oper. force</b> • 11,8 N [2.65 lb]                 </p>		Silver	A	Bottom	30,3 mm [1.19 in]	28,5 mm [1.12 in]	–	<b>14CE2-1</b>
		Gold	B	Bottom	30,3 mm [1.19 in]	28,5 mm [1.12 in]	Gold-plated contacts	<b>14CE2-1G</b>
		Silver	C	Bottom	30,3 mm [1.19 in]	28,5 mm [1.12 in]	dc-type connector	<b>14CE2-Q</b>
		Silver	A	Side	30,3 mm [1.19 in]	28,5 mm [1.12 in]	Side exit cable	<b>14CE2-1A</b>
		Silver	A	Bottom	44,3 mm [1.75 in]	42,5 mm [1.67 in]	Panel mount, 2 m cable	<b>14CE28-2</b>
								
14CE31 • Boot Sealed Roller Plunger		Con- tacts	Elec Rating <sup>1</sup>	Cable Exit	Free Position (FP)	Operating Position (OP)	Options	Listing
 <p> <b>Pretravel</b> • 1,8 mm [0.071 in]  <b>Diff. travel</b> • 0,1 mm [0.004 in]  <b>Overtravel</b> • 3,0 mm [0.118 in]  <b>Oper. force</b> • 17,5 N [3.93 lb]                 </p>		Silver	A	Bottom	36,2 mm [1.43 in]	34,4 mm [1.36 in]	–	<b>14CE31-1</b>
		Silver	A	Bottom	36,2 mm [1.43 in]	34,4 mm [1.36 in]	Fluorocarbon seals, 6 m cable	<b>14CE31-6V</b>
14CE3 • Cross Roller Plunger		Con- tacts	Elec Rating <sup>1</sup>	Cable Exit	Free Position (FP)	Operating Position (OP)	Options	Listing
 <p> <b>Pretravel</b> • 1,8 mm [0.071 in]  <b>Diff. travel</b> • 0,1 mm [0.004 in]  <b>Overtravel</b> • 3,0 mm [0.118 in]  <b>Oper. force</b> • 11,8 N [2.65 lb]                 </p>		Silver	A	Bottom	30,3 mm [1.19 in]	28,5 mm [1.12 in]	–	<b>14CE3-1</b>
		Silver	A	Side	30,3 mm [1.19 in]	28,5 mm [1.12 in]	3 m of cable, side exit	<b>14CE3-3A</b>
		Silver	C	Bottom	30,3 mm [1.19 in]	28,5 mm [1.12 in]	dc-type connector	<b>14CE3-Q</b>

<sup>1</sup> Page 5 for electrical codes

Note: Most part numbers are shown with 1 meter of cable. The -X indicates the number of meters of cable provided: 2-meters, 3-meters, 4-meters, and 5-meters. Custom lengths are also available.

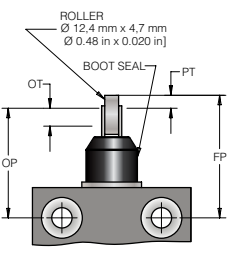
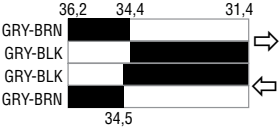
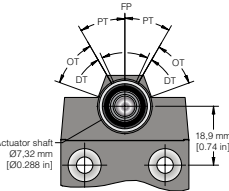
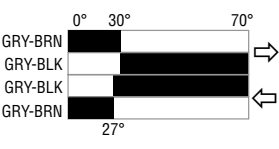
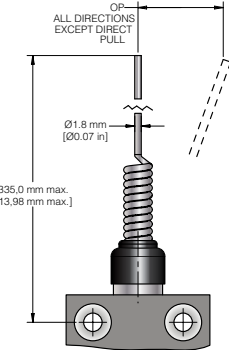
# 14CE Series

14CE55 • Boot Sealed Cross Roller Plunger		Con-tacts	Elec Rating <sup>1</sup>	Cable Exit	Free Position (FP)	Operating Position (OP)	Options	Listing
 <p>ROLLER Ø 12,4 mm x 4,7 mm Ø 0,48 in x 0,020 in</p> <p>OT</p> <p>BOOT SEAL</p> <p>PT</p> <p>OP</p> <p>FP</p>	 <p>36,2 34,4 31,4</p> <p>GRY-BRN</p> <p>GRY-BLK</p> <p>GRY-BLK</p> <p>GRY-BRN</p> <p>34,5</p>	Silver	A	Bottom	36,2 mm [1.43 in]	34,4 mm [1.36 in]	3 meters of cable	<b>14CE55-3</b>
	<p><b>Pretravel</b> • 1,8 mm [0.071 in]</p> <p><b>Diff. travel</b> • 0,1 mm [0.004 in]</p> <p><b>Overtravel</b> • 3,0 mm [0.118 in]</p> <p><b>Oper. force</b> • 17,5 N [3.93 lb]</p>							
14CE16 • Side Rotary		Con-tacts	Elec Rating <sup>1</sup>	Cable Exit	Free Position (FP)	Operating Position (OP)	Options	Listing
 <p>Actuator shaft Ø 7,32 mm [0,288 in]</p> <p>18,9 mm [0,74 in]</p> <p>OT</p> <p>PT</p> <p>FP</p>	 <p>0° 30° 70°</p> <p>GRY-BRN</p> <p>GRY-BLK</p> <p>GRY-BLK</p> <p>GRY-BRN</p> <p>27°</p>	Silver	A	Bottom	–	–		<b>14CE16-1<sup>2</sup></b>
	<p><b>Pretravel</b> • 30°</p> <p><b>Diff. travel</b> • 3°</p> <p><b>Overtravel</b> • 40°</p> <p><b>Oper. force</b> • 0,34 Nm [3 in-lb]</p>							
			Gold	B	Bottom	–	–	Gold-plated contacts, 3 meters of cable
		Silver	C	Bottom	–	–	dc-type connector	<b>14CE16-Q<sup>2</sup></b>
14CE20 • Random Motion Wire Actuator Wobble		Con-tacts	Elec Rating <sup>1</sup>	Cable Exit	Free Position (FP)	Operating Position (OP)	Options	Listing
 <p>OP</p> <p>ALL DIRECTIONS EXCEPT DIRECT PULL</p> <p>Ø 1,8 mm [0,07 in]</p> <p>335,0 mm max. [13,98 mm max.]</p>	 <p>0 28 max.</p> <p>GRY-BRN</p> <p>GRY-BLK</p> <p>GRY-BLK</p> <p>GRY-BRN</p>	Silver	A	Bottom	–	28 mm [1.10 in] max.	–	<b>14CE20-1</b>
	<p><b>Oper. position</b> • 28 mm [1.10 in] max.</p> <p><b>Oper. force</b> • 0,55 N [0.12 lb] max.</p>							

<sup>1</sup> Page 5 for electrical codes

<sup>2</sup> Switch operates on clockwise and counterclockwise rotation of lever shaft

Note: Most part numbers are shown with 1 meter of cable. The -X indicates the number of meters of cable provided: 2-meters, 3-meters, 4-meters, and 5-meters. Custom lengths are also available.

# MICRO SWITCH™ Compact Precision Limit Switches

## This Honeywell datasheet supports the following MICRO SWITCH™ 14CE Series Limit Switch Listings

14CE1-1	14CE1-5	14CE18-3	14CE2-2	14CE2-6	14CE3-1L1
14CE1-1A	14CE1-5K	14CE18-6	14CE2-20	14CE2-6KV	14CE31-L1
14CE1-1G	14CE1-5KV	14CE18-6A	14CE2-2A	14CE27-1	14CE3-2
14CE1-1K	14CE1-6	14CE18-6AH	14CE2-2B	14CE2-7A	14CE3-3
14CE1-2	14CE16-1	14CE18-Q	14CE2-2-D	14CE28-2	14CE3-3A
14CE1-2B	14CE16-10	14CE1-9A	14CE2-2K	14CE2-AQ	14CE3-3AH
14CE1-2G	14CE16-1H	14CE1-AQ	14CE2-2KV	14CE2-Q	14CE3-3K
14CE1-2L	14CE16-2	14CE1-Q	14CE2-3	14CE3-1	14CE3-3KV
14CE1-3	14CE16-3	14CE20-1	14CE2-3A	14CE3-10	14CE3-4AG
14CE1-3A	14CE16-3G	14CE20-3	14CE2-3AH	14CE31-1	14CE3-6
14CE1-3AH	14CE16-4	14CE20-6	14CE2-3D	14CE31-10A	14CE3-GLQ
14CE1-3AK	14CE1-6KV	14CE20-8	14CE2-3G	14CE31-2L	14CE3-Q
14CE1-3AKV	14CE16-Q	14CE2-1	14CE2-3K	14CE31-3	14CE55-3
14CE1-3AL	14CE1-7	14CE2-10	14CE2-3KV	14CE31-4A	14CE66-1
14CE1-3DG	14CE18-1	14CE2-1A	14CE2-4	14CE31-6	14CE66-1A
14CE1-3G	14CE18-15A	14CE2-1G	14CE2-4	14CE316V	14CE66-2
14CE1-3K	14CE18-1A	14CE2-1K	14CE2-5	14CE3-1K	14CE66-4A
14CE1-4	14CE18-1L	14CE2-1L	14CE2-5KV	14CE3-1L	

# 14CE Series

## ADDITIONAL INFORMATION

The following associated literature is available on the Honeywell Web site at [sensing.honeywell.com](http://sensing.honeywell.com):

- Product installation instructions
- Product range guide
- Product nomenclature tree
- Product application-specific information
  - Limit and enclosed switches application information
  - Limit and enclosed switches operating characteristics
  - Limit and enclosed switches reference standards
  - Limit and enclosed switches typical applications
  - Product flyer: CE Family Miniature Limit Switches

### **WARNING**

#### **PERSONAL INJURY**

**DO NOT USE** these products as safety or emergency stop devices or in any other application where failure of the product could result in personal injury.

**Failure to comply with these instructions could result in death or serious injury.**

### **WARNING**

#### **MISUSE OF DOCUMENTATION**

- The information presented in this product sheet is for reference only. Do not use this document as a product installation guide.
- Complete installation, operation, and maintenance information is provided in the instructions supplied with each product.

**Failure to comply with these instructions could result in death or serious injury.**

## WARRANTY/REMEDY

Honeywell warrants goods of its manufacture as being free of defective materials and faulty workmanship. Honeywell's standard product warranty applies unless agreed to otherwise by Honeywell in writing; please refer to your order acknowledgement or consult your local sales office for specific warranty details. If warranted goods are returned to Honeywell during the period of coverage, Honeywell will repair or replace, at its option, without charge those items it finds defective. **The foregoing is buyer's sole remedy and is in lieu of all other warranties, expressed or implied, including those of merchantability and fitness for a particular purpose. In no event shall Honeywell be liable for consequential, special, or indirect damages.**

While we provide application assistance personally, through our literature and the Honeywell website, it is up to the customer to determine the suitability of the product in the application.

Specifications may change without notice. The information we supply is believed to be accurate and reliable as of this printing. However, we assume no responsibility for its use.

**Find out more**

Honeywell serves its customers through a worldwide network of sales offices, representatives and distributors. For application assistance, current specifications, pricing or name of the nearest Authorized Distributor, contact your local sales office.

To learn more about Honeywell's sensing and control products, call **+1-815-235-6847** or **1-800-537-6945**, visit **sensing.honeywell.com**, or e-mail inquiries to **info.sc@honeywell.com**

Sensing and Control  
Honeywell  
1985 Douglas Drive North  
Golden Valley, MN 55422  
**honeywell.com**

The Honeywell logo is displayed in a bold, red, sans-serif font.