

# FAN/FINGER GUARDS

Designer's Choice



## METAL GUARDS

Made of high quality C-1010 carbon steel wire which combines strength with superior forming. The units offer clean, strong butt welds with minimum flash and have consistent guard diameters to enhance maximum air-flow and venting. Guards are nickel chrome plated.

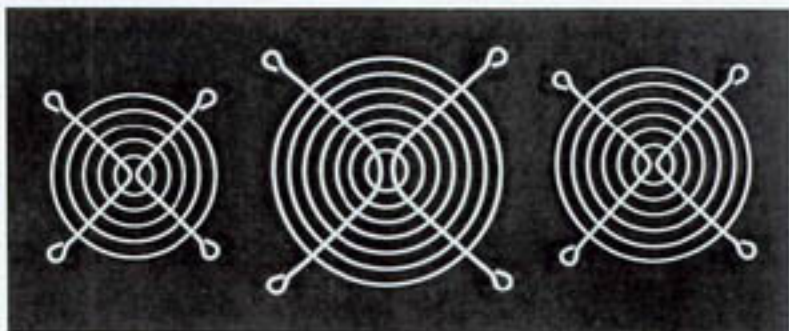

### FITS 1 1/2" FANS

40mm

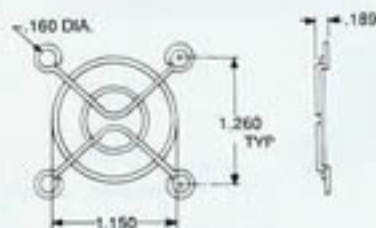

**CONSTRUCTION**  
Rings: .063 wire dia.  
Ribs: .063 wire dia.

CAT. NO. 8447

### FITS 2 1/2" FANS

60mm

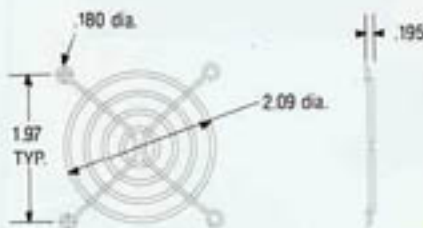

**CONSTRUCTION**  
Rings: .063 wire dia.  
Ribs: .063 wire dia.

CAT. NO. 8449

### FITS 3 1/8" FANS

80mm

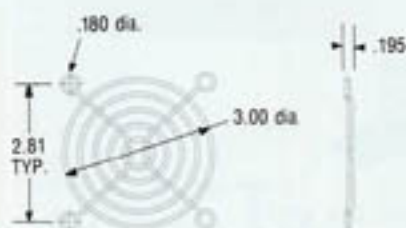

**CONSTRUCTION**  
Rings: .063 wire dia.  
Ribs: .071 wire dia.

CAT. NO. 8450

### FITS 3 5/8" FANS

92mm

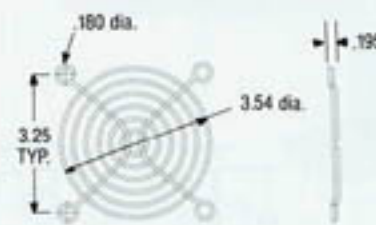

**CONSTRUCTION**  
Rings: .063 wire dia.  
Ribs: .071 wire dia.

CAT. NO. 8451

### FITS 4 1/2" FANS

120mm

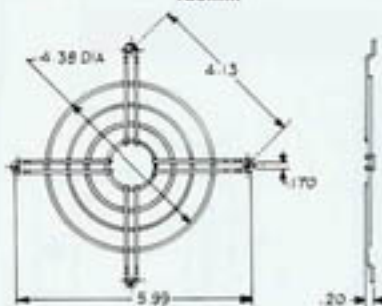

**CONSTRUCTION**  
Rings: .063 wire dia.  
Ribs: .063 wire dia.

CAT. NO. 8448

### FITS 4 1/2" FANS

120mm

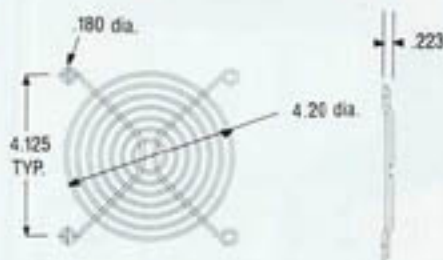

**CONSTRUCTION**  
Rings: .071 wire dia.  
Ribs: .091 wire dia.

CAT. NO. 8452

### FITS 4 1/2" FANS

120mm

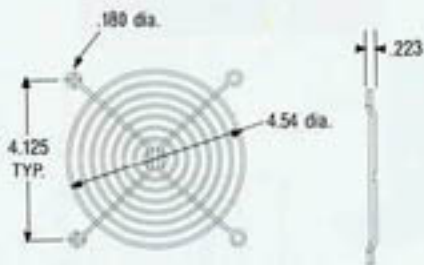

**CONSTRUCTION**  
Rings: .071 wire dia.  
Ribs: .071 wire dia.

CAT. NO. 8453

### FITS 6" FANS

150mm

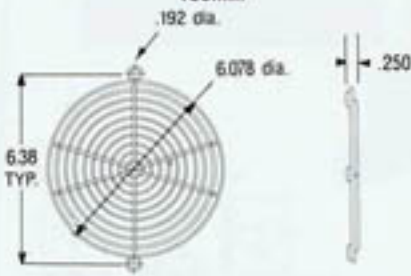

**CONSTRUCTION**  
Rings: .071 wire dia.  
Ribs: .091 wire dia.

CAT. NO. 8455

### FITS 10" FANS

254mm

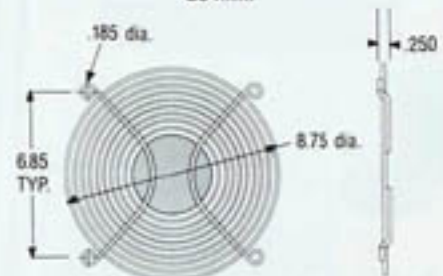

**CONSTRUCTION**  
Rings: .091 wire dia.  
Ribs: .091 wire dia.

CAT. NO. 8457

# FAN/FINGER GUARDS

Designer's  
Choice



## METAL GUARDS

Made of high quality C-1010 carbon steel wire which combines strength with superior forming. The units offer clean, strong butt welds with minimum flash and have consistent guard diameters to enhance maximum air-flow and venting. Guards are nickel chrome plated.

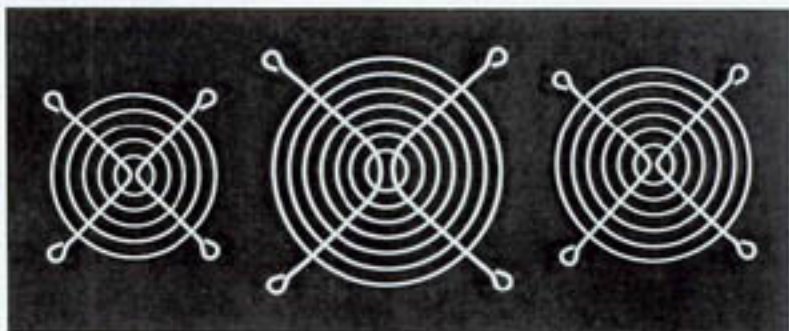

### FITS 1 1/2" FANS

40mm

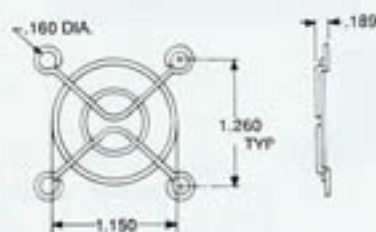

**CONSTRUCTION**  
Rings: .063 wire dia.  
Ribs: .063 wire dia.

CAT. NO. 8447

### FITS 2 1/2" FANS

60mm

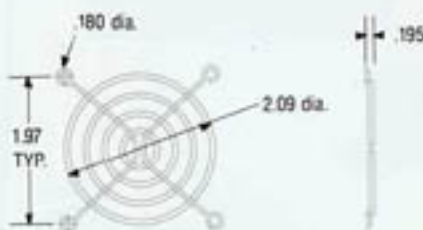

**CONSTRUCTION**  
Rings: .063 wire dia.  
Ribs: .063 wire dia.

CAT. NO. 8449

### FITS 3 1/8" FANS

80mm

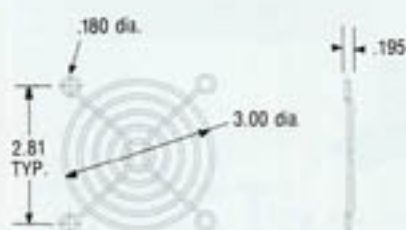

**CONSTRUCTION**  
Rings: .063 wire dia.  
Ribs: .071 wire dia.

CAT. NO. 8450

### FITS 3 5/8" FANS

92mm

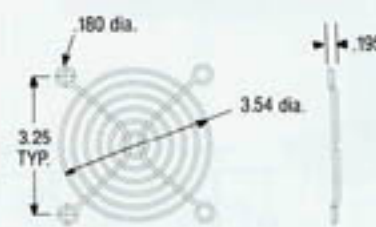

**CONSTRUCTION**  
Rings: .063 wire dia.  
Ribs: .071 wire dia.

CAT. NO. 8451

### FITS 4 1/2" FANS

120mm

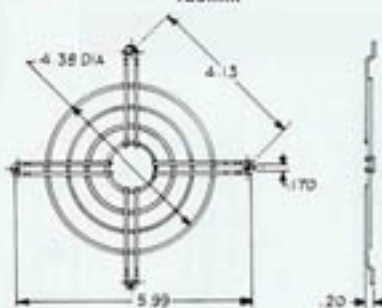

**CONSTRUCTION**  
Rings: .063 wire dia.  
Ribs: .063 wire dia.

CAT. NO. 8448

### FITS 4 1/2" FANS

120mm



**CONSTRUCTION**  
Rings: .071 wire dia.  
Ribs: .091 wire dia.

CAT. NO. 8452

### FITS 4 1/2" FANS

120mm

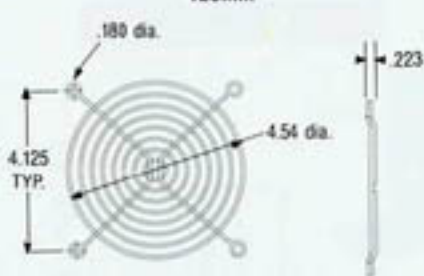

**CONSTRUCTION**  
Rings: .071 wire dia.  
Ribs: .071 wire dia.

CAT. NO. 8453

### FITS 6" FANS

150mm

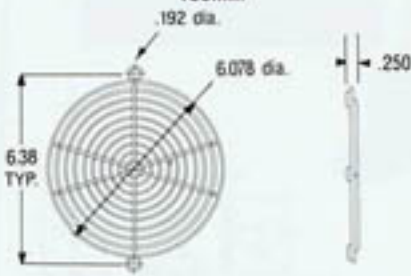

**CONSTRUCTION**  
Rings: .071 wire dia.  
Ribs: .091 wire dia.

CAT. NO. 8455

### FITS 10" FANS

254mm

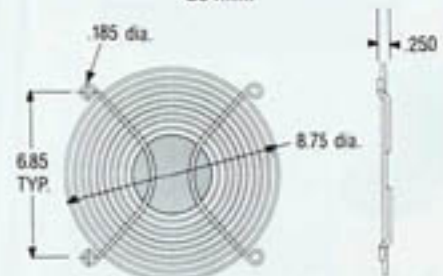

**CONSTRUCTION**  
Rings: .091 wire dia.  
Ribs: .091 wire dia.

CAT. NO. 8457