



BREMAS

BETTER SWITCHES

MICROSWITCHES

M3 series



06

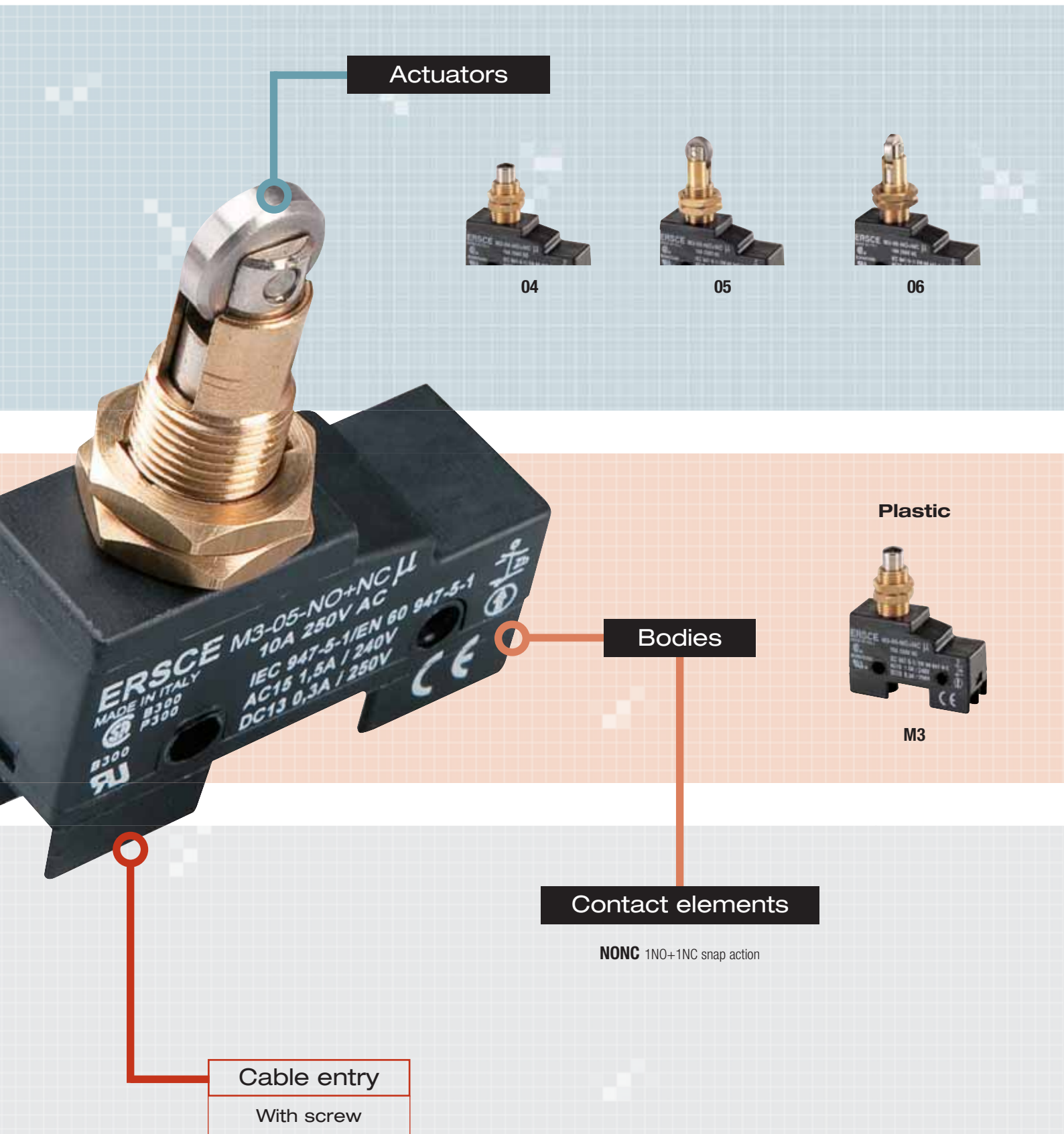



Product code structure

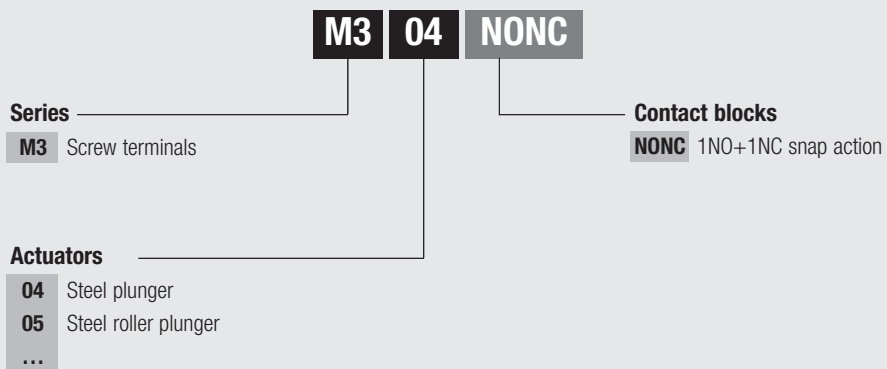

Note: Please verify the effective availability of a product before ordering.

Technical information

		TIPO	M3
Maximum operating frequency		operat./hour ¹	1800
Insulation resistance		500 V DC MΩ	100
Dielectric strenght		50/60 Hz per 1'	2500 ²
Rated insulation voltage	Ui	IEC947-5-1 V AC	250
Rated thermal current	Ithe	IEC947-5-1 A	10
Rated operating current	Category AC15 A300	le IEC947-5-1/EN60947-5-1 24V	A 5
		125V	A 3
		230 V	A 1,5
Contact resistance		IEC255-7 cat.3 initial value mΩ	25 max
Short circuit protective devices		IEC269 (IEC947-5-1) fuse type gL or gG	A 3
Pollution degree		IEC947-5-1	A 3
Protection degree		EN 60529	IP40
Vibration resistance		IEC68-2-6 mm	0,35 ± 15% (10 ÷ 55 Hz ± 1 Hz)
Shock resistance		IEC68-2-27 11ms	g 30
Mechanical life			cycles 15.000.000
Electric life		at 250V AC 6A with resistance load cosφ=1	cycles 500.000
		at 250V AC 6A with inductive load cosφ=0,4	cycles 500.000
Terminals	Type		Screw with combined notch and retractable plate (notch Ph. Size 1)
	Screw		M3,5
	Protection degree		IP00 (IP40 with terminals cover)
	Material		Steel class 8,8 / Galvanized
	Max. screw tightening torque		120 (12,24)
	Max connecting capacity	rigid cable	mm ²
flexible cable		mm ²	2x1,5
with prod terminal			1x1,5
Terminal numbering			In accordance with EN50013
Air ambient temperature		operational °C	-25 ÷ +85 (without formation of ice)
Relative umidity		operational	95% max

¹ One operation cycle means two movements, one to close and one to open as required by EN 60947-5

² Between terminals with different polarity; between live mechanical parts and ground; between live mechanical parts and non-current-carrying metal parts

Certifications and Approvals



- UL approval file E72861
- CSA approval file 026716-0-00
- Approved
- + Conforms to requirements

**M3
series**

- Extremely compact
- Plastic body
- Metal actuators
- Galvanically separated contacts type Zb
- Gold plated contacts (on request)
- Contact elements 1NO+1NC snap action with positive opening of the NC contact in accordance to IEC EN 60947-5-1 and VDE 0660-200

Series	Product	Fixing holes
M3		

Galvanically separated contacts type Zb

The NO and NC contacts are galvanically separated with positive opening: it is possible to use the contacts independently.

**High performance contacts**

Ag/Ni.

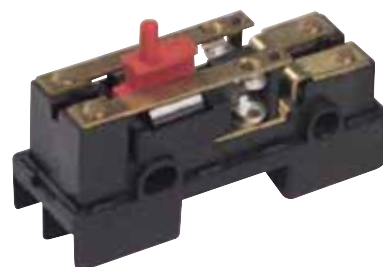

Actuation heads

■ Plunger actuation



04

Steel and
plunger Ø 8,3

05

Steel roller
plunger

06

Steel roller
plunger
turned 90°

■ Lever actuation



08

Lever,
length 54 mm

09

Lever,
length 63.5 mm

10

Steel and lever

11

Thermoplastic
roller lever,
length 26,6

13

Thermoplastic
roller lever,
length 37

14

Thermoplastic
roller lever,
length 50,5

Operating characteristics

Plungers, roller plunger, vertical travel

Actuators: M...04-05-06

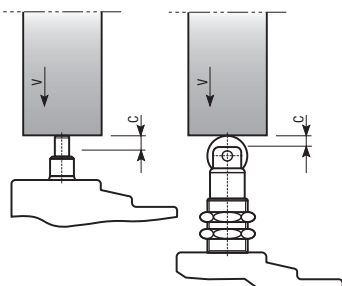

Drive force	
Minimum operating force	4 N
Minimum positive opening force	16 N

Levers, roller lever, vertical action

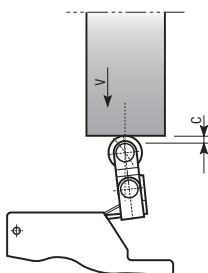

Drive forces	
Actuators: M...11	
Minimum operating force	2 Ncm
Minimum positive opening force	13 Ncm
Actuators : M...08-13	
Minimum operating force	1,6 Ncm
Minimum positive opening force	12 Ncm
Actuators : M...09-14	
Minimum operating force	1,3 Ncm
Minimum positive opening force	11 Ncm

Roller plunger, side travel

Actuators: M...05-06

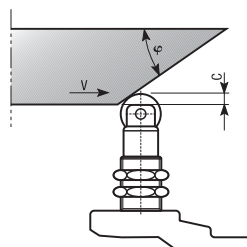

Operating parameters of the drive cam	
φ	V max (m/s)
30°	0,2
20°	0,5

Roller lever, side action

Actuators: M...11-13-14

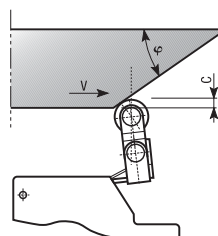

Operating parameters of the drive cam	
φ	V max (m/s)
30°	0,5
45°	0,3
60°	0,2

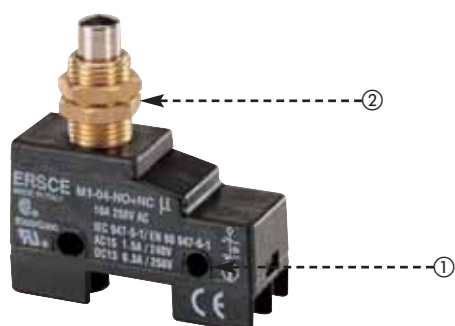

Tightening torque

- ① Tighten the fixing screws of the appliance with a torque of 1.2÷1.5 Nm
- ② Max tightening torque 4 Nm for drives fixed in place with hexagonal nuts

04



Steel plunger Ø8,3 mm

Contact element	
1NO+1NC snap action	
13 21 14 22	
Weight pack	kg
Pack	pcs

Plastic	Contact travel
M304NONC	
0,925	
5	

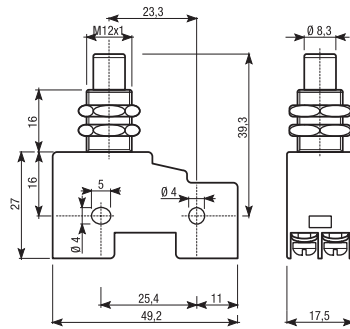

05



Steel roller plunger

Plastic	Contact travel
M305NONC	
1,105	
5	

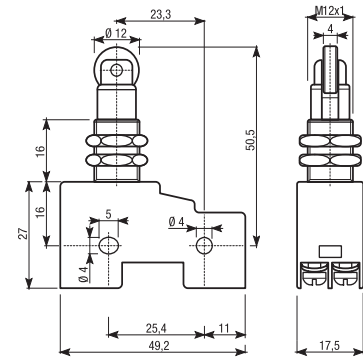

Drive cam operating parameters

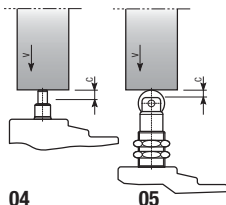

Min. force (N)	
for tripping	4
for positive opening	16

04

05



Steel roller plunger turned 90°

Contact element	
1NO+1NC snap action	
13 21	
Zb	
14 22	
Weight pack	kg
Pack	pcs

Plastic	Contact travel
M306NONC	
1,105	
5	

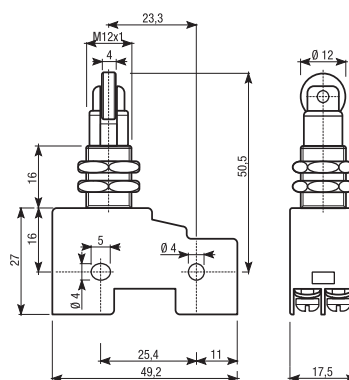

Drive cam operating parameters

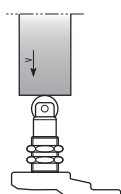

Min. force (N)	
for tripping	4
for positive opening	16

08



Lever length 54 mm

Contact element	
1NO+1NC snap action	
13 21 Zb 14 22	
Weight pack	kg
Pack	pcs

Plastic	Contact travel
M308NONC	
0,360	
5	

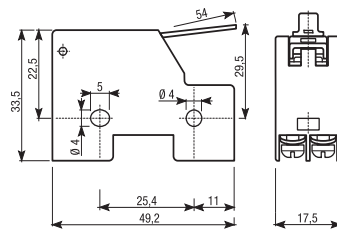

09



Lever length 63,5 mm

Plastic	Contact travel
M309NONC	
0,365	
5	

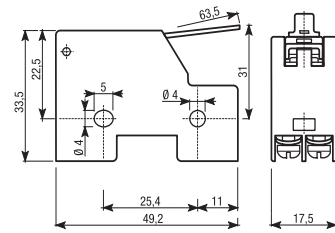

Drive cam operating parameters

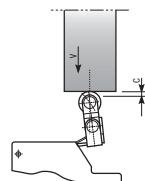

Min. force (cNm)	
for tripping	1,6
for positive opening	12

11



Thermoplastic roller lever
length 26,6 mm

Contact element	
1NO+1NC snap action	
13 21	
Zb	
14 22	
Weight pack	kg
Pack	pcs

Plastic	Contact travel
M311NONC	
0,735	
5	

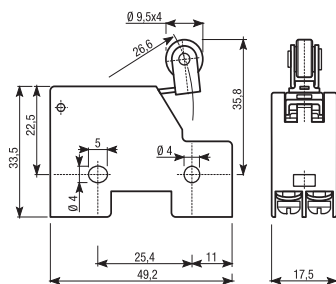

13



Thermoplastic roller lever
length 37 mm

Plastic	Contact travel
M313NONC	
0,745	
5	

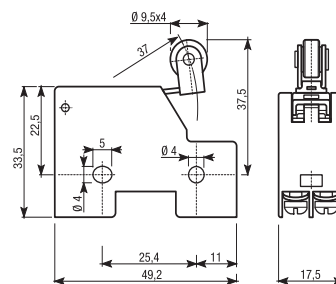

Drive cam operating parameters

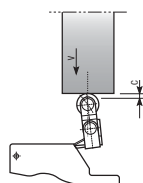

Min. force (cNm)	
for tripping	2
for positive opening	13

Min. force (cNm)	
for tripping	1,6
for positive opening	12



Thermoplastic roller lever
length 50,5 mm

Contact element	
1NO+1NC azione rapida	
Weight pack	kg
Pack	pcs

Plastic	Contact travel
M314NONC	
0,755	
5	

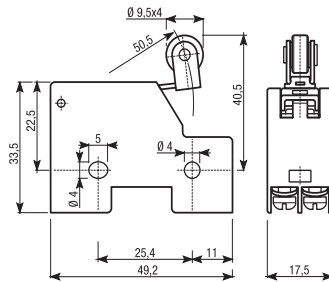

Accessory:
terminal cover for M3 series

Plastic
M3PROTA
0,195
5

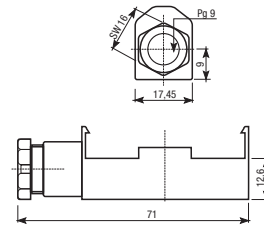

Drive cam operating parameters

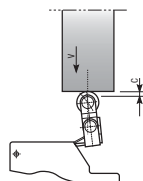

Min. force (cNm)	
for tripping	1,3
for positive opening	11